

PARTS LIST

Reference	Qty	Description
A	(2)	3.5" Square Poles -12' Long
B	(1)	Collar with Reel and Hardware
C	(1)	Collar with Pulley
D	(6)	Collar with Eye bolts
	(2)	Pole Caps
SOLD SEPARATELY		
E	(1)	34"H Unicourt Net, custom size for court dimension (Length of net should be 4' shorter than post spacing to allow for 2' of bungee tension on each side.)
F	(4)	Bungee Cords (included with net)
G	(1)	Pair of 42" SQ Ground Sleeves (#68150AL) (SGS-42SQ) (Recommended but optional)

SOLD SEPARATELY

E	(1)	34"H Unicourt Net, custom size for court dimension (Length of net should be 4' shorter than post spacing to allow for 2' of bungee tension on each side.)
F	(4)	Bungee Cords (included with net)
G	(1)	Pair of 42" SQ Ground Sleeves (#68150AL) (SGS-42SQ) (Recommended but optional)

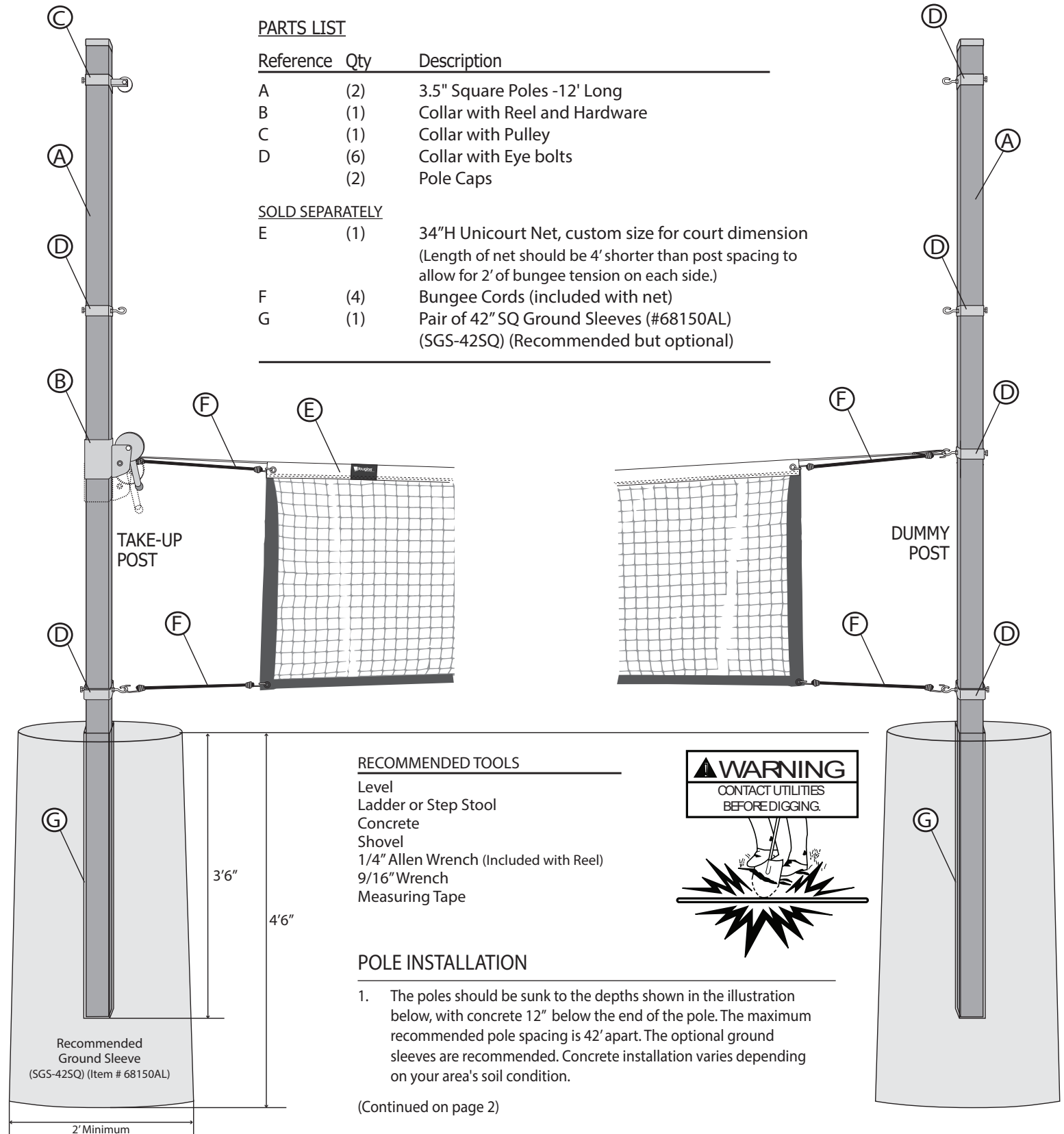

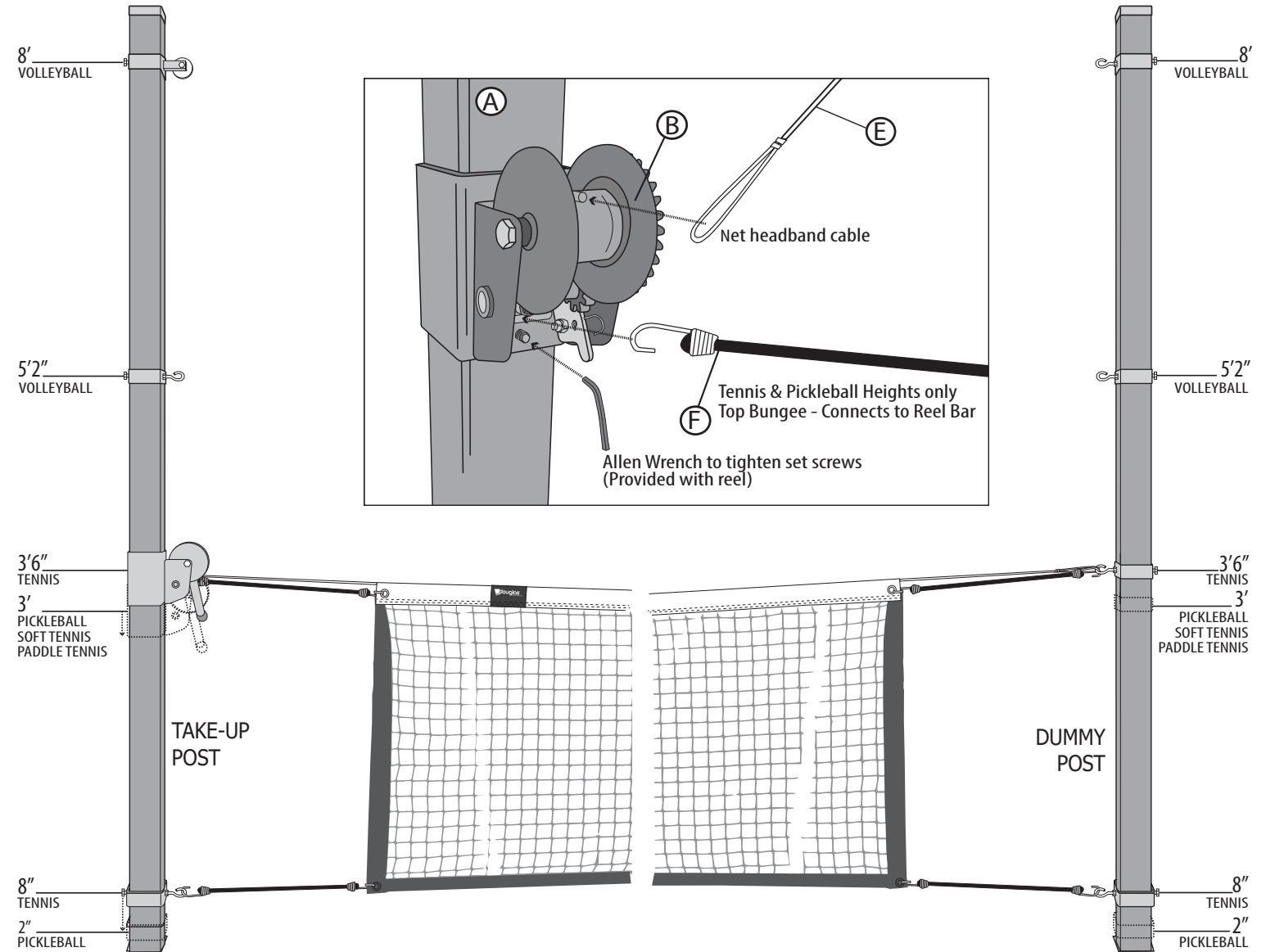

POLE INSTALLATION (Continued from page 1)

- Slide reel and all collars over the top of poles according to the illustration. Secure reel and collars according to the indicated sport heights. For this you will need a 9/16" wrench and a ladder.
- To secure collars, use a 9/16" wrench and tighten each bolt on the backside of the pole.
- To set the reel in place, use the provided Allen wrench to tighten the set screws on the front of the pole. One set screw is underneath the reel, and the other is above the reel.
- Tighten the components just enough to set the collars in place. Over-tightening will make it difficult to reset the collars for net height adjustments.
- Secure the handle to the reel and place caps on the tops of the poles.

*Collar attachment locations are approximate. Field adjustments may be required to reach the desired net height.

**To change the height setting, the net must be completely removed and reinstalled, and the reel and collars must be adjusted to the desired heights.

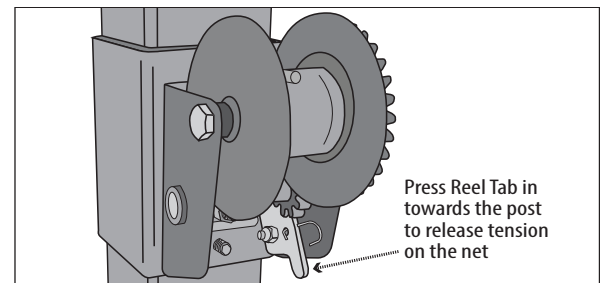



3.5" Square Steel Adjustable Net System

Item # 681255

TENNIS - NET INSTALLATION

1. If needed, take down the net and then adjust the collars to the necessary positions, as shown in the illustration. For this, you'll need a wrench and maybe a ladder. On the take-up post, the reel must be set at 3'6", and the bottom eye bolt collar needs to be set at 8" from the ground. Likewise, on the dummy side, a middle eye bolt collar needs to be set at 3'6", and the bottom eye bolt collar needs to be set at 8" from the ground.
2. Attach one headband cable loop to the middle eye bolt on the dummy post set to 3'6".
3. On the take-up side, attach the other net cable loop to the hook on the reel. Turn the reel handle clockwise and begin cranking until the net is taught between the posts.
4. Use (2) bungee cords on the dummy post to secure the net. The top bungee cable shares an eye bolt with the headband cable.
5. Use (2) bungee cords on the take-up post to tighten the net. The top bungee cord connects to the bar underneath the reel.

TENNIS
3'6" Net Headband Height

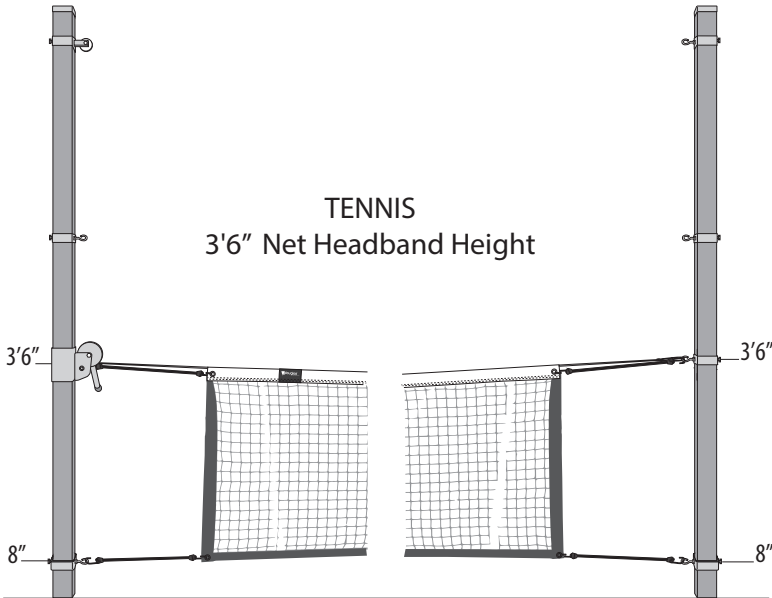

PICKLEBALL - NET INSTALLATION

1. If needed, take down the net and then adjust the collars to the necessary positions, as shown in the illustration. For this, you'll need a wrench and maybe a ladder. On the take-up post, the reel must be set at 3', and the bottom eye bolt collar needs to be set at 2" from the ground. Likewise, on the dummy side, a middle eye bolt collar needs to be set at 3', and the bottom eye bolt collar needs to be set at 2" from the ground.
2. Attach one headband cable loop to the middle eye bolt on the dummy post set to 3'.
3. On the take-up side, attach the other net cable loop to the hook on the reel. Turn the reel handle clockwise and begin cranking until the net is taught between the posts.
4. Use (2) bungee cords on the dummy post to secure the net. The top bungee cable shares an eye bolt with the headband cable.
5. Use (2) bungee cords on the take-up post to tighten the net. The top bungee cord connects to the bar underneath the reel.

PICKLEBALL
(PADDLE TENNIS, SOFT TENNIS, POP TENNIS)
3' Net Headband Height

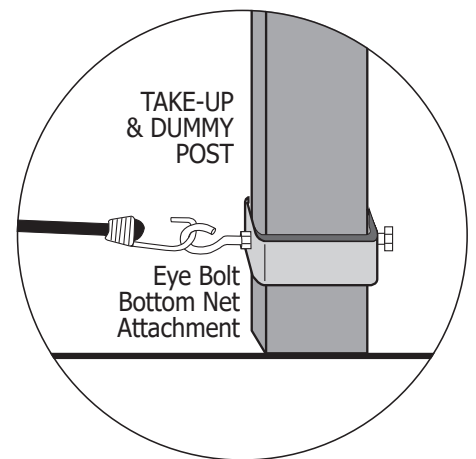
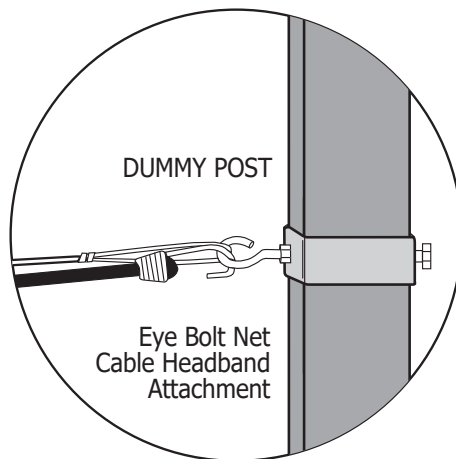
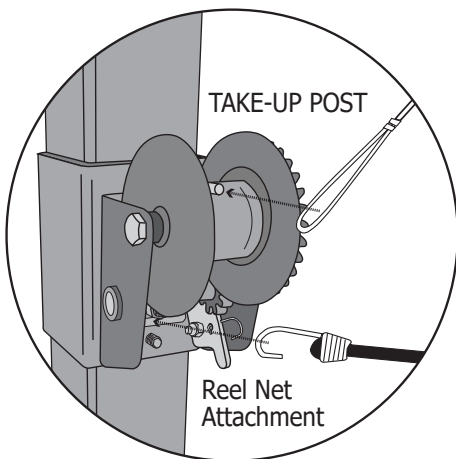
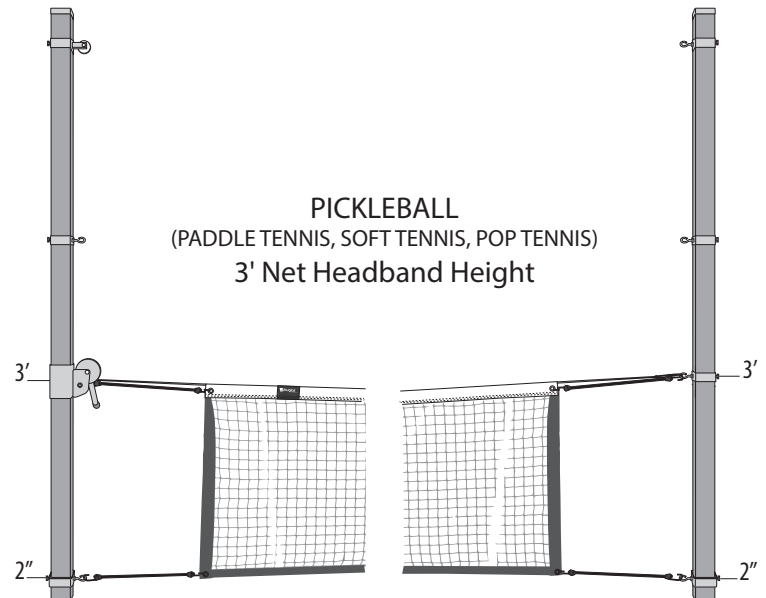

VOLLEYBALL - NET INSTALLATION

1. If needed, take down the net and then adjust the collars to the necessary positions, as shown in the illustration. For this, you will need a wrench and a ladder. On the take-up post, the top pulley collar needs to be set at 8', and the bottom middle eye bolt collar needs to be set at 5'2" from the ground. Likewise, on the dummy side, the top eye bolt collar needs to be set at 8' and the middle collar needs to be set at 5'2" from the ground.
2. Attach one headband cable loop to the top eye bolt on the dummy post set at 8'.
3. On the take-up side, pull the cable loop over and down through the top pulley set at 8'.
4. Continue pulling the net cable loop down to the hook on the reel. Turn the reel handle clockwise and begin cranking until the net is taugth between the posts.
5. Use (2) bungee cords on the dummy post to secure the net. The top bungee cable shares an eye bolt with the headband cable.
6. Use (2) bungee cords on the take-up post to tighten the net. The top bungee cord connects to the headband cable that is tightened to the reel.

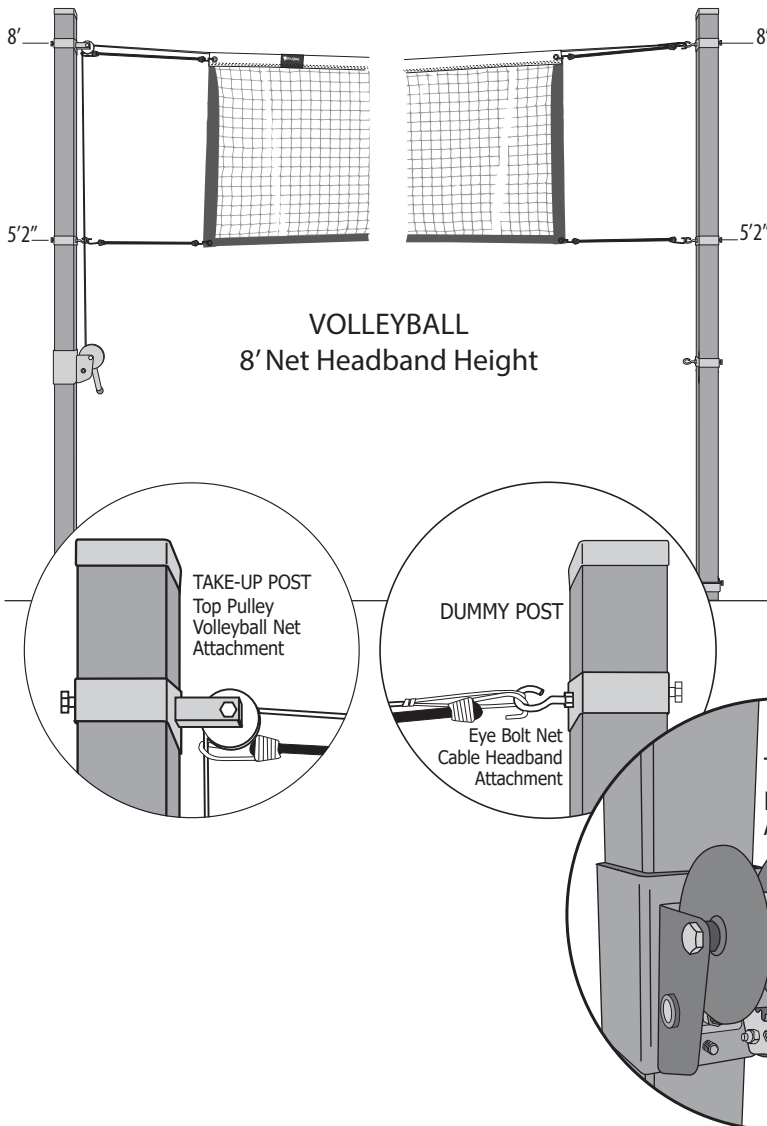

BADMINTON - NET INSTALLATION

1. If needed, take down the net and then adjust the collars to the necessary positions, as shown in the illustration. For this, you will need a wrench and a ladder. On the take-up post, the top pulley collar needs to be set at 5'2", and the bottom collar needs to be moved up to 2'4" from the ground. Likewise, on the dummy side, the middle eye bolt collar must be set at 5'2", and the bottom collar must be set at 2'4" from the ground.
2. Attach one headband cable loop to the top eye bolt on the dummy post set at 5'2".
3. On the take-up side, pull the cable loop over and down through the top pulley set at 5'2".
4. Continue pulling the net cable loop down to the hook on the reel. Turn the reel handle clockwise and begin cranking until the net is taugth between the posts.
5. Use (2) bungee cords on the dummy post to secure the net. The top bungee cable shares an eye bolt with the headband cable.
6. Use (2) bungee cords on the take-up post to tighten the net.

